

MFC-240C

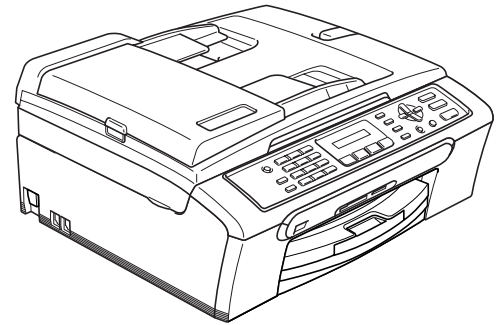

Before you can use the machine, you must set up the hardware and install the software. Please read this Quick Setup Guide for the correct setup procedure and installation instructions.

STEP 1

Setting Up the Machine





**STEP 2**

Installing the Driver & Software

Setup is Complete!

Keep this Quick Setup Guide, the User's Guide and the supplied CD-ROM in a convenient place for quick and easy reference at all times.

Symbols used in this guide

 Warning	 Caution	 Improper Setup
Warnings tell you what to do to prevent possible personal injury.	Cautions specify procedures you must follow or avoid to prevent possible damage to the machine or other objects.	Improper Setup icons alert you to devices and operations that are not compatible with the machine.
 Note	 User's Guide or Software User's Guide	
Notes tell you how you should respond to a situation that may arise or give tips about how the current operation works with other features.	Indicates reference to the User's Guide or Software User's Guide we have supplied.	

Getting Started

Carton components	2
Control panel	3

STEP1 – Setting Up the Machine

Removing the protective parts	4
Loading paper	4
Connecting the phone line	6
Connecting the power cord	6
Set Your Country (For Australia / New Zealand Customer Only).....	7
Installing the ink cartridges.....	7
Print quality check.....	10
Choosing your language	10
Setting the LCD contrast.....	11
Setting the date and time	11
Setting your station ID.....	12
Setting tone or pulse dialling mode (not available for New Zealand).....	12
Choosing a Receive Mode.....	13

STEP2 – Installing the Driver & Software

Windows®

For USB Interface Users (For Windows® 98/98SE/Me/2000 Professional/XP/XP Professional x64 Edition).....	16
--	----

Macintosh®

For USB Interface Users (For Mac OS® X 10.2.4 or greater)	19
--	----

Uninstalling the ‘MFL-Pro Suite’

For instructions on how to uninstall the MFL Pro Suite software	22
Uninstalling for Windows.....	22
Uninstalling for Macintosh	22
How to uninstall the Printer Driver:	22
How to uninstall the Scanner Driver:.....	22







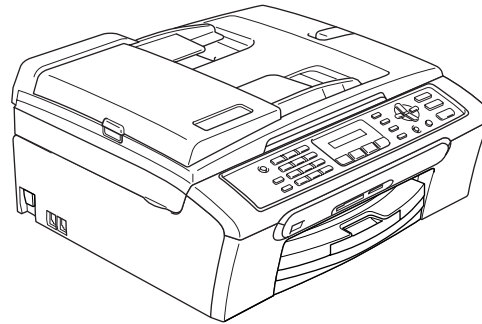

Consumables

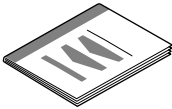
Replacement consumables	23
Ink cartridge	23

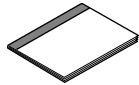

Carton components

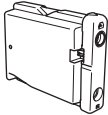
Carton components may vary from one country to another.
Save all packing materials and the carton in case for any reason you must ship your machine.

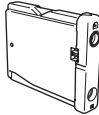
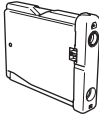

 Quick Setup Guide	 CD-ROM	 User's Guide	
 Telephone Line Cord	 Power Cord	 Telephone Line Cord Adapter (For Australia only)	
 Black (LC57BK)	 Yellow (LC57Y)	 Cyan (LC57C)	 Magenta (LC57M)

A USB interface cable is not a standard accessory.

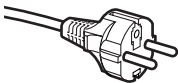
<p>Australia & New Zealand users:</p>  <p>The mains plug supplied with this machine is a grounded three pin plug. Make sure that the AC socket will accept this grounded three pin plug. This machine must be grounded, If in doubt, call a qualified electrician.</p>	<p>Hong Kong, Malaysia & Singapore users:</p>  <p>The mains plug supplied with this machine is a grounded three pin plug. Make sure that the AC socket will accept this grounded three pin plug. This machine must be grounded, If in doubt, call a qualified electrician.</p>
<p>Philippines & Thailand users:</p>  <p>The mains plug supplied with this machine is a side grounded two pin plug. Make sure that the AC socket will accept this side grounded two pin plug. This machine must be grounded, If in doubt, call a qualified electrician.</p>	

- To ensure safe operation the supplied plug must be inserted only into a standard power outlet that is properly grounded through the standard electrical wiring. Non grounded equipment may cause an electrical shock hazard, and may cause excessive electrical noise radiation.
- Please make sure you use a USB 2.0 cable that is no longer than 2 metres (6 feet) long.
- Your machine has a USB interface that is compatible with the USB 2.0 specification.
- DO NOT connect the interface cable at this time.
Connecting the interface cable is done during the software installation process.

Control panel

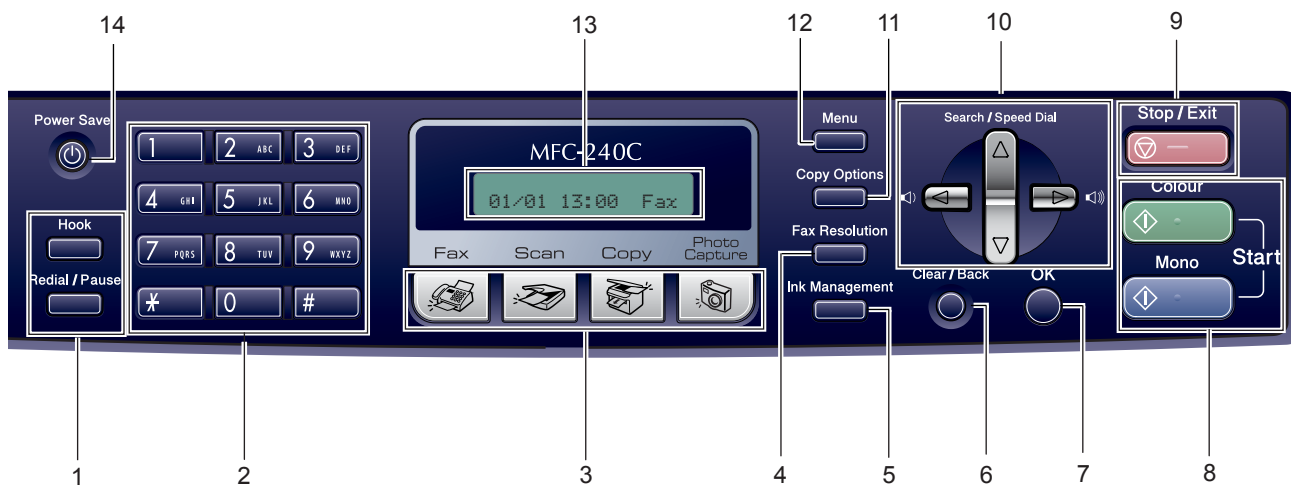

- | | |
|--------------------------|---------------------------------|
| 1 Fax and telephone keys | 8 Start keys |
| 2 Dial Pad | 9 Stop/Exit key |
| 3 Mode keys | 10 Navigation keys |
| 4 Fax Resolution key | 11 Copy Options key |
| 5 Ink Management key | 12 Menu key |
| 6 Clear/Back key | 13 LCD (Liquid Crystal Display) |
| 7 OK key | 14 Power Save key |

 For the details of the control panel, see *Control panel overview* in Chapter 1 of the User's Guide.

Note

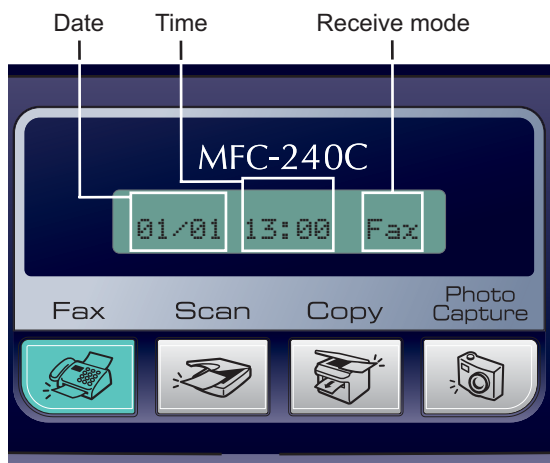

When the machine is idle (not being used) it will return to the default display shown above. The default display shows the date, time, and the current receive mode.

1 Removing the protective parts

- 1 Remove the protective tape and film covering the scanner glass.
- 2 Remove the foam bag containing the ink cartridges from on top of the paper tray.

⊘ Improper Setup

DO NOT connect the USB cable. Connecting the USB cable is done during the software installation process.

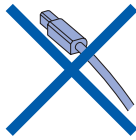

2 Loading paper



*You can load up to 100 sheets of 80 gsm (20 lb) paper.
For details, see Acceptable paper and other media in Chapter 2 of the User's Guide.*

- 1 Pull the paper tray completely out of the machine and lift the output paper tray cover (1).

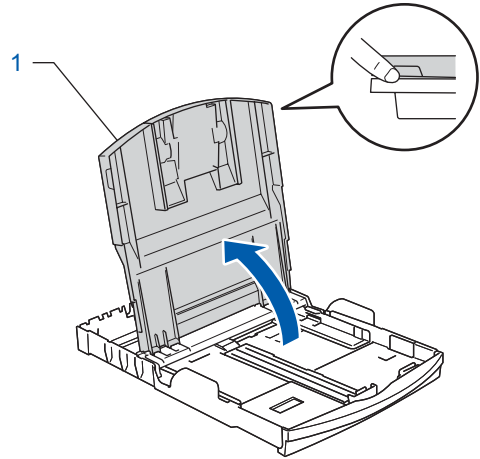
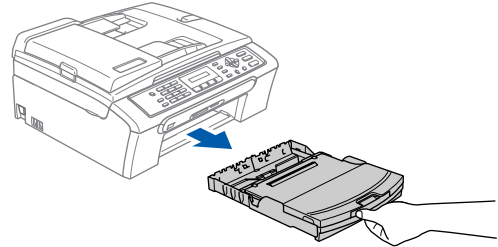

- 2 Press and slide the paper side guides (1) and paper length guide (2) to fit the paper size.

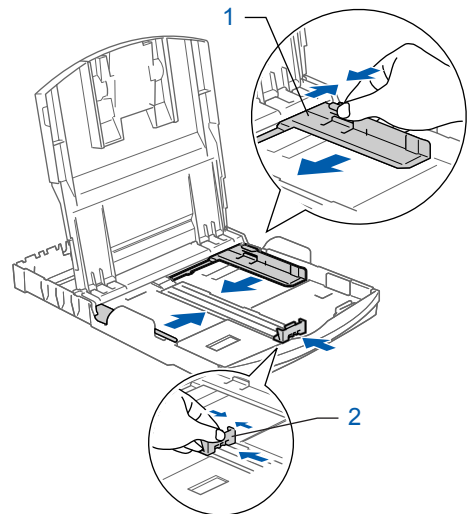

Setting Up the Machine

- 3** Fan the stack of paper well to avoid paper jams and misfeeds.

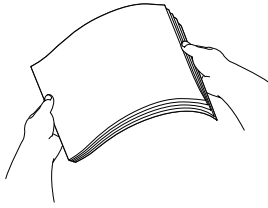

- 4** Gently put the paper into the paper tray print side down and top edge first. Check that the paper is flat in the tray.

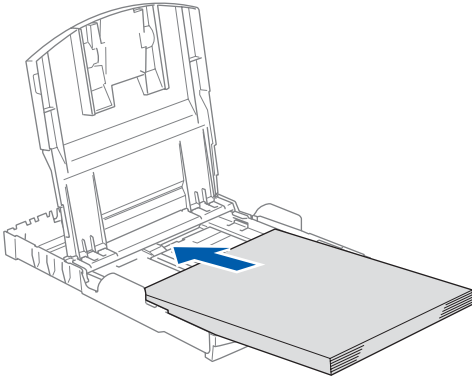

- 5** Gently adjust the paper side guides with both hands to fit the paper. Make sure that the paper guides touch the edges of the paper.

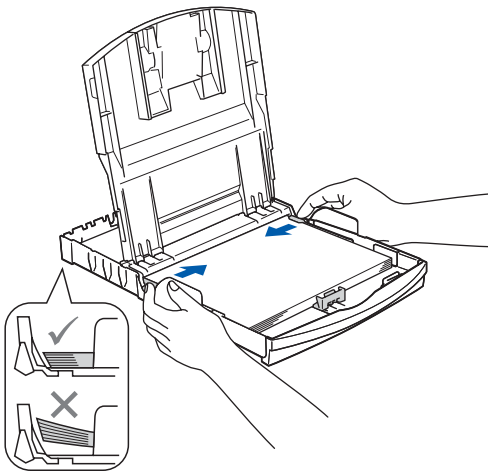

 **Note**

Be careful that you do not push the paper in too far; it may lift at the back of the tray and cause paper feed problems.

- 6** Close the output paper tray cover.

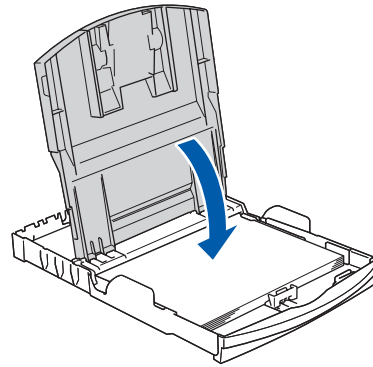

- 7** Slowly push the paper tray completely into the machine.

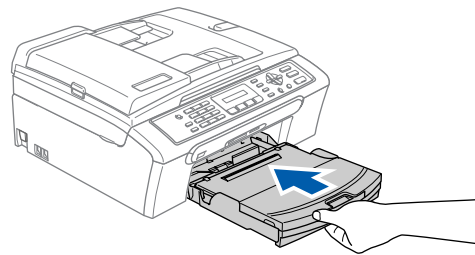

- 8** While holding the paper tray in place, pull out the paper support (①) until it clicks, and then unfold the paper support flap (②).

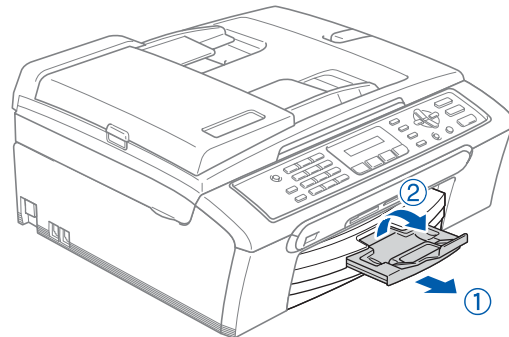

 **Note**

Do not use the paper support flap for Legal size paper.

3 Connecting the phone line

- 1 Connect the telephone line cord. Connect one end of the telephone line cord to the socket on the machine marked **LINE** and the other end to a modular wall socket.

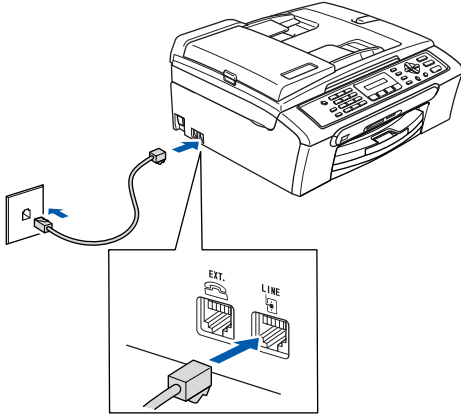

⊘ Improper Setup

DO NOT connect the USB cable. Connecting the USB cable is done during the software installation process.

⚠ Warning

- The machine must be fitted with an earthed plug.
- Since the machine is grounded through the power outlet, you can protect yourself from potentially hazardous electrical conditions on the telephone network by keeping the power cord connected to your machine when you connect it to a telephone line. Similarly, you can protect yourself when you want to move your machine by disconnecting the telephone line first and then the power cord.

📝 Note

If you are sharing one phone line with an external telephone, connect it as shown below.

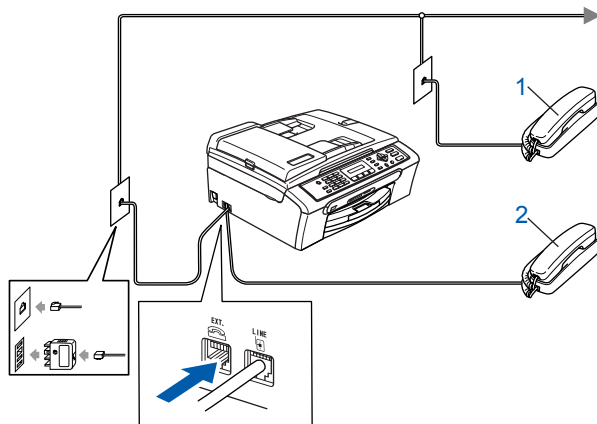

- 1 Extension telephone
- 2 External telephone

📝 Note

If you are sharing one phone line with an external telephone answering machine, connect it as shown below.

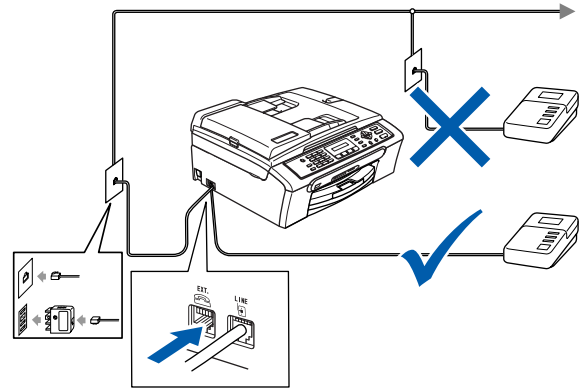

Set the receive mode to 'External TAD' if you have an external answering machine. For details, see *Connecting an external TAD (telephone answering device)* in Chapter 7 of the User's Guide.

4 Connecting the power cord

- 1 Connect the power cord.

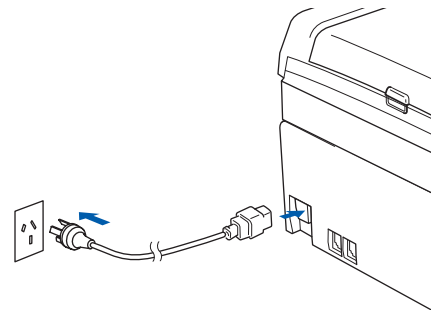

5 Set Your Country (For Australia / New Zealand Customer Only)

You must set your country so that the machine works correctly.

- 1 Check that the power is turned on by connecting the power cord.
The LCD shows:

Set Country



Press OK Key

- 2 Press **OK**.
The LCD shows:

Australia



Select ▲▼ & OK

- 3 Press **▲** or **▼** to select the country
(Australia or New Zealand).

- 4 Press **OK** when the LCD shows your country.

- 5 The LCD prompts you to make sure of the country again.

Australia?



1.Yes 2.No

- 6 Press **1** to go to step **7**.
---OR---
Press **2** to go back to step **1** to select the country again.

- 7 After the LCD shows Accepted for two seconds, it shows; Please Wait.

6 Installing the ink cartridges

! Warning

If ink gets in your eyes, wash them out with water at once, and if irritation occurs consult a doctor.

- 1 Make sure that the power is turned on.
The LCD shows:

No Cartridge

- 2 Open the ink cartridge cover (1).

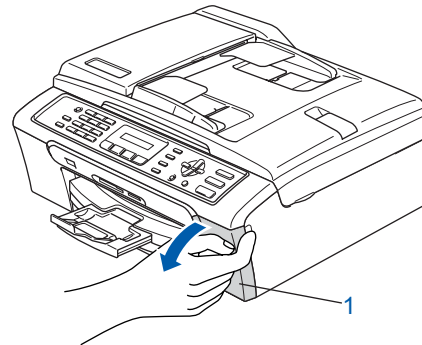

- 3 Pull all the lock release levers down and remove the yellow protective part (1).

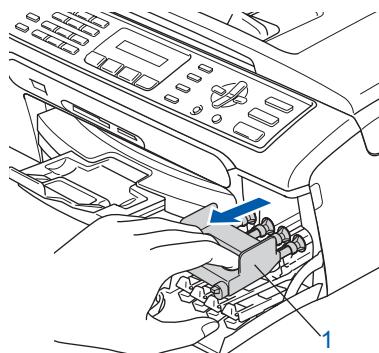
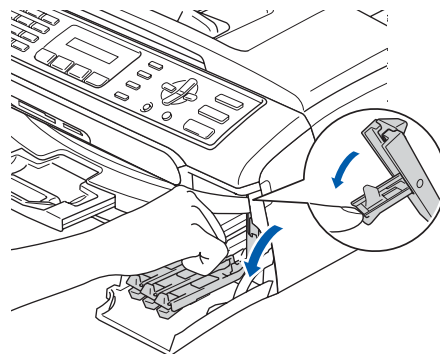

! Note

Do not throw away the yellow protective part. You will need it if you transport the machine.

- 4** Take out the ink cartridge.

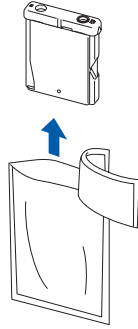

- 5** Carefully remove the protective yellow cap (1).

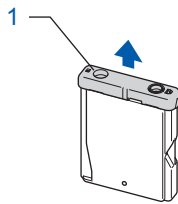

⊘ Improper Setup

DO NOT touch the area shown in the illustration below.

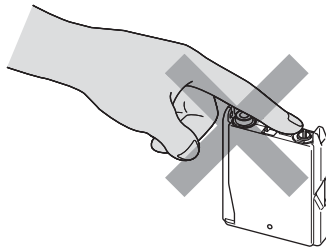

📝 Note

If the protective yellow cap comes off when you open the bag, the cartridge will not be damaged.

- 6** Install each ink cartridge in the direction of the arrow on the label. Take care to match the colour of the lock release lever (1) with the cartridge colour (2), as shown in the diagram below.

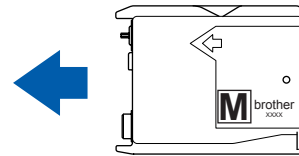
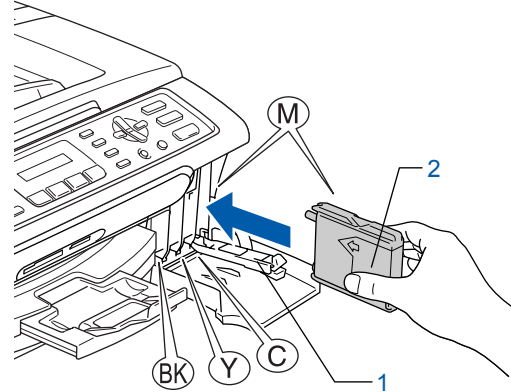

- 7** Lift each lock release lever and push it until it clicks, and then close the ink cartridge cover.

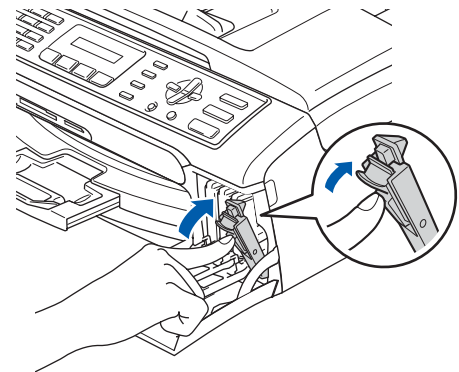

📝 Note

*If the LCD shows **Install Black**, **Install Yellow**, **Install Cyan** or **Install Magenta** after you install the ink cartridges, check that the ink cartridges are installed properly.*

The machine will clean the ink tube system for use for the first time. The cleaning process will last approximately four minutes. The LCD shows:

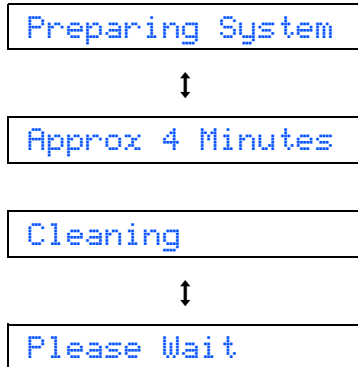

! Caution

- **DO NOT** take out ink cartridges if you do not need to replace them. If you do so, it may reduce the ink quantity and the machine will not know the quantity of ink left in the cartridge.
- **DO NOT** shake the ink cartridges. If ink stains your skin or clothing, wash with soap or detergent at once.
- **DO NOT** repeatedly insert and remove the cartridges. If you do so, ink may seep out of the cartridge.
- If you mix the colours by installing an ink cartridge in the wrong position, clean the print head several times after correcting the cartridge installation. (See *Cleaning the print head in Appendix B of the User's Guide.*)
- Once you open an ink cartridge, install it in the machine and use it up within six months of installation. Use unopened ink cartridges by the expiration date written on the cartridge package.
- **DO NOT** dismantle or tamper with the ink cartridge, this can cause the ink to leak out of the cartridge.
- Brother multifunction machines are designed to work with ink of a particular specification and will work to a level of optimum performance when used with genuine Brother branded ink cartridges. Brother cannot guarantee this optimum performance if ink or ink cartridges of other specifications are used. Brother does not therefore recommend the use of cartridges other than genuine Brother branded cartridges with this machine or the refilling of empty cartridges with ink from other sources. If damage is caused to the print head or other parts of this machine as a result of using incompatible products with this machine, any repairs required as a result may not be covered by the warranty.

7 Print quality check

- 1** After the cleaning cycle is finished, the LCD shows:

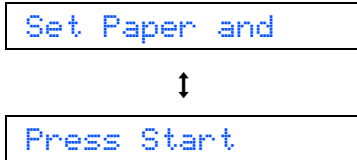

- 2** Make sure paper is loaded in the paper tray. Press **Colour Start**. The machine starts printing the Print Quality Check Sheet (only during initial ink cartridge installation).
- 3** Check the quality of the four colour blocks on the sheet. (black/yellow/cyan/magenta)

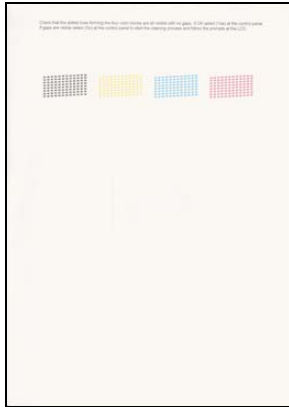

⊘ Improper Setup

Avoid touching the printed surface of the paper immediately after printing, the surface may not be completely dry and may stain your fingers.

- 4** The LCD shows:

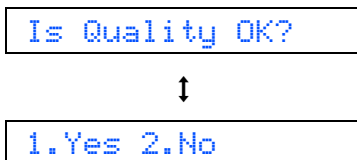

- 5** Do one of the following:
- If all lines are clear and visible, press **1** (Yes) on the dial pad to finish the quality check.
 - If you can see missing short lines, press **2** (No) on the dial pad and go to step **6**.

OK

Poor

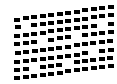
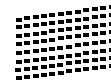

- 6** The LCD asks you if the print quality is OK for black and colour. Press **1** (Yes) or **2** (No) on the dial pad.

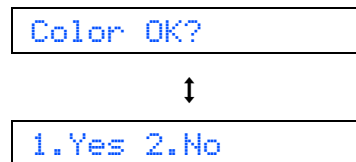
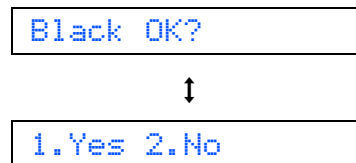

After pressing **1** (Yes) or **2** (No) for both black and colour, the LCD shows:

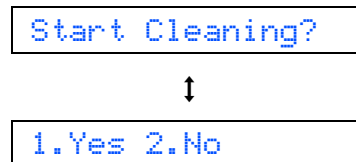

- 7** Press **1** (Yes), the machine will then start cleaning the colours.

- 8** After cleaning is finished, press **Colour Start**. The machine starts printing the Print Quality Check Sheet again and goes back to step **3**.

8 Choosing your language

You can change the LCD language.

- 1** Press **Menu, 0, 0**.
- 2** Press **▲** or **▼** to choose your language (English or Spanish). Press **OK**.
- 3** Press **Stop/Exit**.

9 Setting the LCD contrast

You can adjust the LCD contrast for a sharper and more vivid display. If you are having difficulty seeing the LCD from your position, we recommend the following contrast setting for improved viewing.

- 1 Press **Menu**, 1, 7.
- 2 Press **▲** or **▼** to choose **Dark** or **Light**.
- 3 Press **OK**.
- 4 Press **Stop/Exit**.

Contrast:Light



Contrast:Dark



10 Setting the date and time

The machine displays the date and time, and if you set up the station ID, the date and time displayed on your machine will be printed on every fax you send.

- 1 Press **Menu**.
- 2 Press **0**.
- 3 Press **2**.
- 4 Enter the last two digits of the year on the dial pad, and then press **OK**.

Year:2007

(e.g. Enter **07** for 2007.)

- 5 Enter the two digits for the month on the dial pad, and then press **OK**.

Month:03

(e.g. Enter **03** for March.)

- 6 Enter the two digits for the day on the dial pad, and then press **OK**.

Day:01

(e.g. Enter **01** for the first of the month.)

- 7 Enter the time in 24-hour format on the dial pad, and then press **OK**.

Time:15:25

(e.g. Enter **15, 25** for 3:25 P.M.)

- 8 Press **Stop/Exit**.



To confirm the current date and time, print out the Users Settings Report. (See Printing reports in Chapter 9 of the User's Guide.)

11 Setting your station ID

You should store your name and fax number to be printed on all fax pages that you send.

- 1 Press **Menu**.
- 2 Press **0**.
- 3 Press **3**.
- 4 Enter your fax number (up to 20 digits) on the dial pad, and then press **OK**. To enter a "+" for international codes, press **✕**. For example, to enter the UK dialling code "+44", press **✕**, 4, 4 and then the rest of your number.

Fax: +44XXXXXXXX

- 5 Enter your name (up to 20 characters) using the dial pad, and then press **OK**.

Name: _



Note

- See the following chart for entering your name.
- If you need to enter a character that is on the same key as the last character, press to move the cursor to the right.
- If you entered a letter incorrectly and want to change it, press or to move the cursor under the incorrect character, press **Clear/Back**.

Press key	One time	Two times	Three times	Four times
2	A	B	C	2
3	D	E	F	3
4	G	H	I	4
5	J	K	L	5
6	M	N	O	6
7	P	Q	R	S
8	T	U	V	8
9	W	X	Y	Z

- 6 Press **Stop/Exit**.



Note

If you make a mistake and want to start again, press **Stop/Exit** and go back to step 1.



For details, see *Entering Text* in Appendix C of the User's Guide.

12 Setting tone or pulse dialling mode (not available for New Zealand)

Your machine comes set for a Tone dialling service. If you have a Pulse dialling service (rotary), you need to change the dialling mode.

- 1 Press **Menu**.
- 2 Press **0**.
- 3 Press **4**.
- 4 Press **▲** or **▼** to choose **Pulse** (or **Tone**). Press **OK**.
- 5 Press **Stop/Exit**.

13 Choosing a Receive Mode

There are four possible receive modes: Fax Only, Fax/Tel, Manual and External TAD.

Now go to

Go to *Supplied CD-ROM 'MFL-Pro Suite'* on the next page to install the drivers.

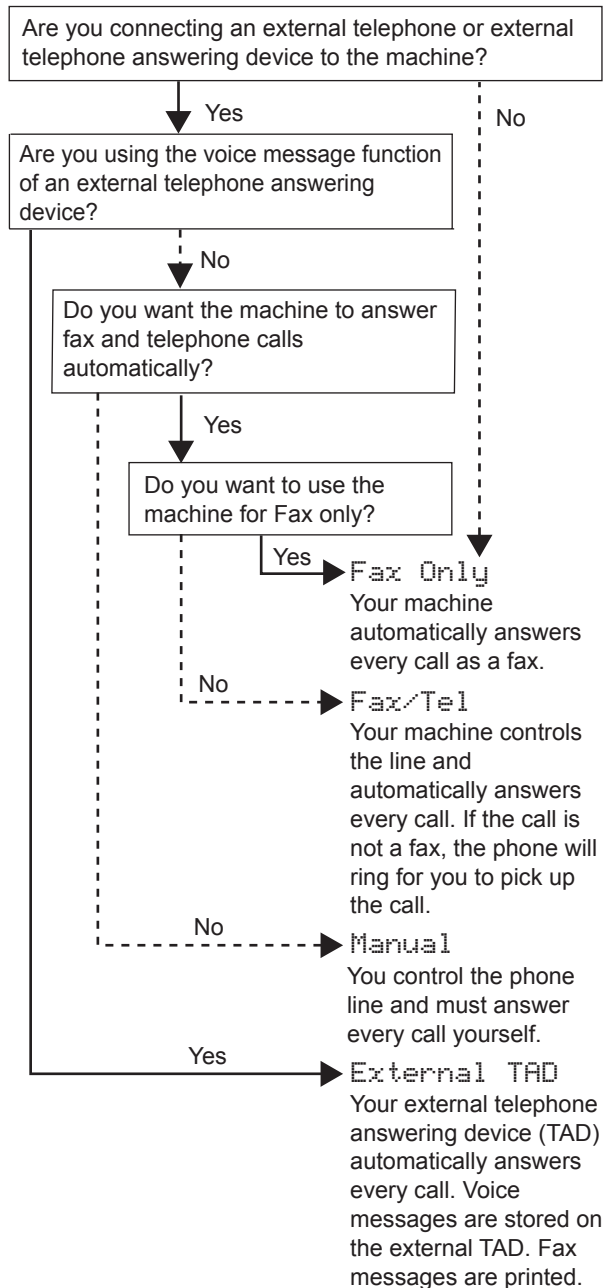

- 1 Press **Menu**.
- 2 Press **0**.
- 3 Press **1**.
- 4 Press **▲** or **▼** to choose the mode.
- 5 Press **OK**.
- 6 Press **Stop/Exit**.



For details, see *Receive mode Settings* in Chapter 6 of the *User's Guide*.

Supplied CD-ROM 'MFL-Pro Suite'

Windows®

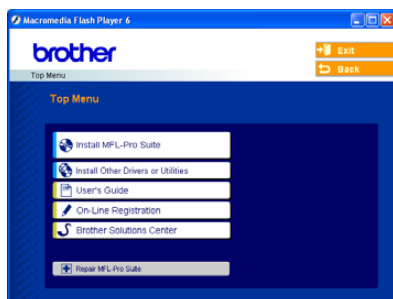

Install MFL-Pro Suite

You can install the MFL-Pro Suite software and multifunction drivers.



Install Other Drivers or Utilities

You can install additional MFL-Pro Suite software utilities, install without PaperPort® SE, or install the printer driver only.



User's Guide

View the Software User's Guide in HTML format. The Software User's Guide includes instructions for features available when connected to a computer. (eg. Printing and scanning details)



On-Line Registration

You will be pointed to the Brother Product Registration Web page for quick registration of your machine.



Brother Solutions Center

You can access the Brother Solutions Center which is a Web site offering information about your Brother product including FAQs, User's Guides, driver updates and tips for using your machine.



Repair MFL-Pro Suite

If an error occurred during the installation of the MFL-Pro Suite, use this selection to automatically repair and re-install the MFL-Pro Suite.



Note

MFL-Pro Suite includes the Printer Driver, Scanner Driver, Brother ControlCenter3, ScanSoft® PaperPort® SE with OCR and True Type® fonts.

PaperPort® SE with OCR is a document management application for scanning and viewing documents.

Macintosh®

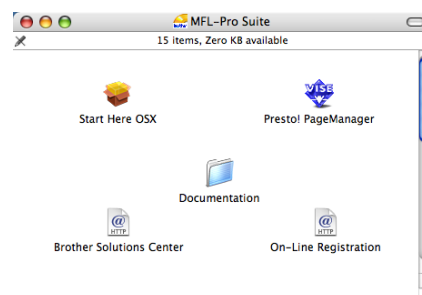

Start Here OSX

You can install the MFL-Pro Suite that includes the printer driver, scanner driver and the Brother ControlCenter2 for Mac OS® 10.2.4 or greater.



Presto! PageManager

You can also install Presto!® PageManager® to add OCR capability to the Brother ControlCenter2 and easily scan, share and organize photos and documents.



Documentation

View the Software User's Guide in HTML format. The Software User's Guide includes instructions for features available when connected to a computer. (eg. Printing and scanning details)



Brother Solutions Center

You can access the Brother Solutions Center which is a Web site offering information about your Brother product including FAQs, User's Guides, driver updates and tips for using your machine.



On-Line Registration

You will be pointed to the Brother Product Registration Web Page for quick registration of your machine.

Follow the instructions on this page for your operating system and interface.

For the latest drivers and documentations and to find the best solution for your problem or question, access the Brother Solutions Center directly from the driver or visit <http://solutions.brother.com>.

Windows®



For USB Interface Users

(For Windows® 98/98SE/Me/2000 Professional/XP/XP Professional x64 Edition) 16

Macintosh®



For USB Interface Users

(For Mac OS® X 10.2.4 or greater) 19

For USB Interface Users

(For Windows® 98/98SE/Me/2000 Professional/XP/XP Professional x64 Edition)

Important

Make sure that you have finished the instructions from Step 1 *Setting Up the Machine* on pages 4 through 13.

Note

- Uninstall any other version of MFC software, any scanning and faxing software and any GDI printer drivers as they might cause conflicts with new software.
- Please close any applications running before installing MFL-Pro Suite.
- Make sure there are no memory cards in the media drive of the machine.

- 1 Disconnect the machine from the power socket and from your computer, if you already connected an interface cable.

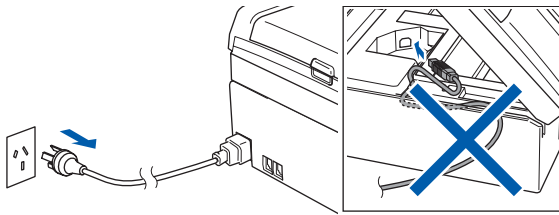

- 2 Turn on your PC.
(For Windows® 2000 Professional/XP/XP Professional x64 Edition, you must be logged on with Administrator rights.)

- 3 Put the supplied CD-ROM into your CD-ROM drive. If the model name screen appears, choose your machine. If the language screen appears, choose your language.



- 4 The CD-ROM main menu will appear. Click **Install MFL-Pro Suite**.



Note

- If this window does not appear, use Windows® Explorer to run the **setup.exe** program from the root folder of the Brother CD-ROM.
- If you are using Windows® 2000 Professional and have not installed service pack 3 (SP3) or greater:

To access the PhotoCapture Center™ features from your computer you may have to install a Windows® 2000 update first.

The Windows® 2000 update is included with the MFL-Pro Suite installer.

To install the update, follow the steps below:

- 1 Click **OK** to start installation of the Windows® updates.

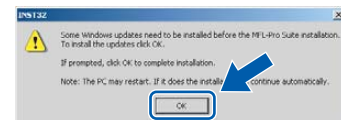

- 2 When instructed, click **OK** to restart your computer.
- 3 After the computer restarts, the installation of MFL-Pro Suite will automatically continue. If the installation does not continue automatically, open the main menu again by ejecting and then reinserting the CD-ROM disc or double-click the **setup.exe** program from the root folder, and continue from Step 4 to install MFL-Pro Suite.

- 5** After reading and accepting the ScanSoft® PaperPort® SE License Agreement, click **Yes**.

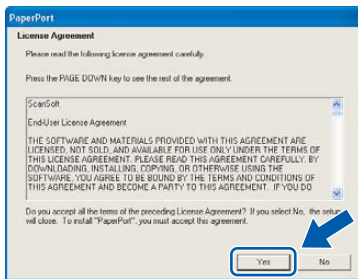

- 6** The installation of PaperPort® SE will automatically start and is followed by the installation of MFL-Pro Suite.

- 7** When the Brother MFL-Pro Suite Software License Agreement window appears, click **Yes** if you agree to the Software License Agreement.

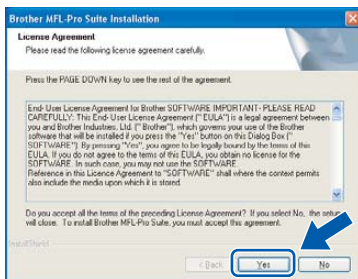

- 8** Choose **Standard**, and then click **Next**. The installation continues.

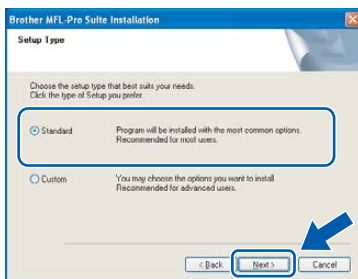

- 9** When this screen appears, go to the next step.

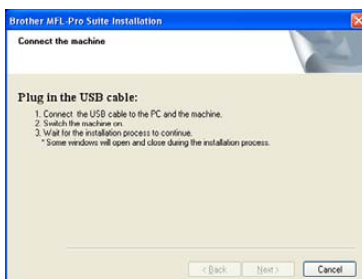

- 10** Using both hands, use the plastic tabs on both sides of the machine to lift the scanner cover until it locks securely into the open position.

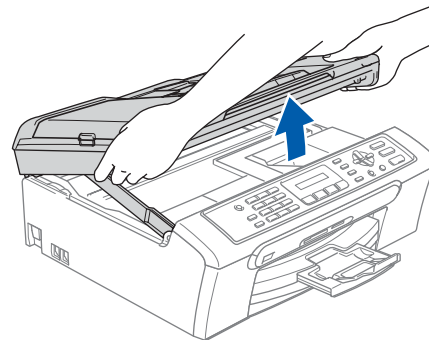

- 11** Connect the USB cable to the USB socket marked with a  symbol. You will find the USB socket inside the machine as shown below.

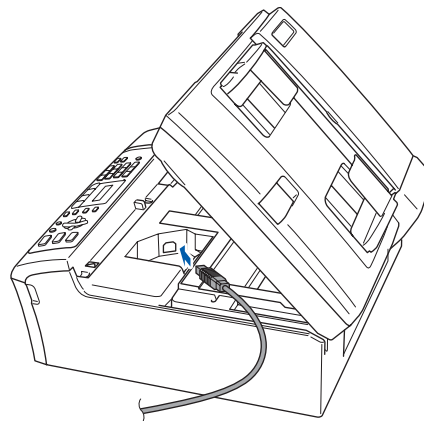

- 12** Carefully guide the USB cable into the trench as shown below, following the trench around and toward the back of the machine and connect it to your computer.

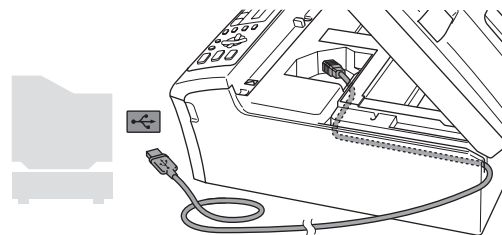

⊘ Improper Setup

- **DO NOT** connect the machine to a USB port on a keyboard or a non-powered USB hub. Brother recommends that you connect the machine directly to your computer.
- Make sure that the cable does not restrict the cover from closing, or an error may occur.
- Please make sure you use a USB 2.0 cable that is no longer than 2 metres long (6 feet).

- 13** Lift the scanner cover to release the lock (①). Gently push the scanner cover support down (②) and close the scanner cover (③).

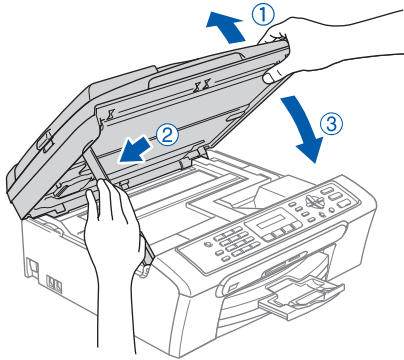

- 14** Turn on the machine by connecting the power cord.

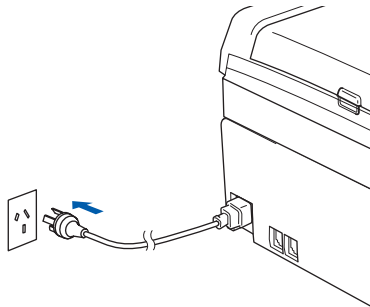

The installation of the Brother drivers will automatically start. The installation screens appear one after another. **Please wait, it will take a few seconds for all the screens to appear.**

⊘ Improper Setup

DO NOT try to cancel any of the screens during this installation.

- 15** When the On-Line Registration screen is displayed, make your selection and follow the on-screen instructions.

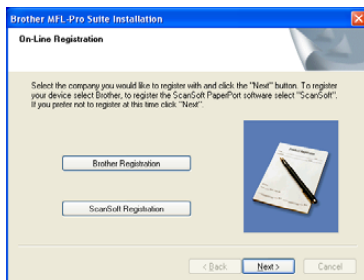

- 16** Click **Finish** to restart your computer. (After restarting the computer, for Windows® 2000 Professional/XP/XP Professional x64 Edition, you must be logged on with Administrator rights.)

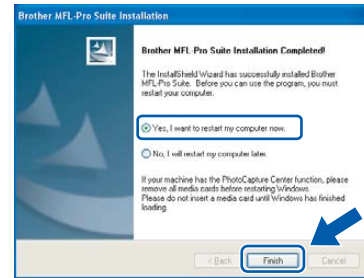

Note

After restarting the computer, the Installation Diagnostics will run automatically. If the installation is unsuccessful, the installation results window will be shown. If the Diagnostics shows a failure, please follow the on-screen instructions or read the on-line help and FAQs in **Start/All Programs (Programs)/Brother/MFC-XXXX**.



The MFL-Pro Suite has been installed and the installation is now complete.

Note

MFL-Pro Suite includes the Printer Driver, Scanner Driver, Brother ControlCenter3, ScanSoft® PaperPort® SE with OCR and True Type® fonts.

PaperPort® SE with OCR is a document management application for scanning and viewing documents.

For USB Interface Users (For Mac OS® X 10.2.4 or greater)

Important

Make sure that you have finished the instructions from Step 1 *Setting Up the Machine* on pages 4 through 13.

Note

For Mac OS® X 10.2.0 to 10.2.3 users, upgrade to Mac OS® X 10.2.4 or greater. (For the latest information for Mac OS® X, visit <http://solutions.brother.com>)

- Using both hands, use the plastic tabs on both sides of the machine to lift the scanner cover until it locks securely into the open position.

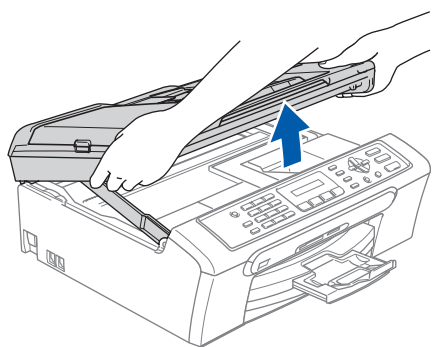

- Connect the USB cable to the USB socket marked with a  symbol. You will find the USB socket inside the machine as shown below.

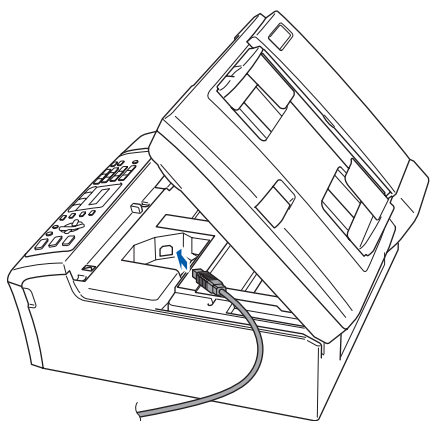

- Carefully guide the USB cable into the trench as shown below, following the trench around and toward the back of the machine and connect it to your computer.

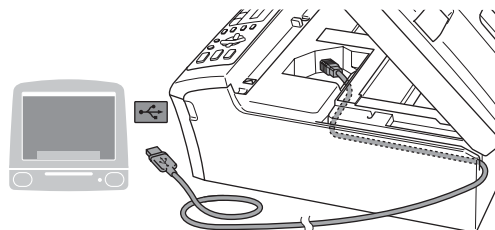

Macintosh®
USB

⊘ Improper Setup

- DO NOT connect the machine to a USB port on a keyboard or a non-powered USB hub. Brother recommends that you connect the machine directly to your computer.
- Make sure that the cable does not restrict the cover from closing, or an error may occur.
- Please make sure you use a USB 2.0 cable that is no longer than 2 metres long (6 feet).

- Lift the scanner cover to release the lock (①). Gently push the scanner cover support down (②) and close the scanner cover (③).

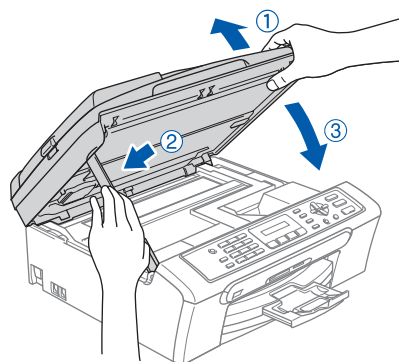

Note

Make sure that the machine is turned on by connecting the power cord.

- 5 Turn on your Macintosh®.
- 6 Put the supplied CD-ROM into your CD-ROM drive.



- 7 Double-click the **Start Here OSX** icon to install. Follow the on-screen instructions.

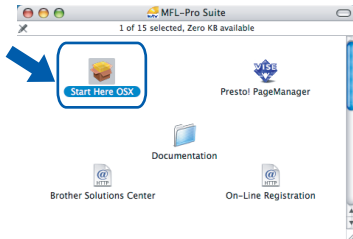

Note

Please wait, it will take a few seconds for the software to install. After the installation, click **Restart** to finish installing the software.

- 8 The Brother software will search for the Brother device. During this time the following screen will appear.

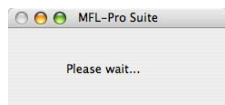

- 9 When this screen appears, click **OK**.



OK! For Mac OS® X 10.3.x or greater users: The MFL-Pro Suite, Brother printer driver, scanner driver and Brother ControlCenter2 have been installed and the installation is now complete. Go to step 14.

- 10 For Mac OS® X 10.2.4 to 10.2.8 users: Click **Add**.

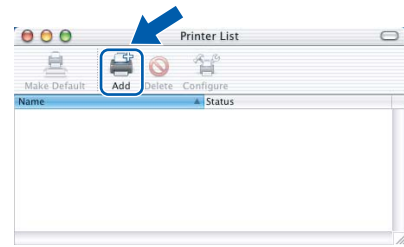

- 11 Choose **USB**.

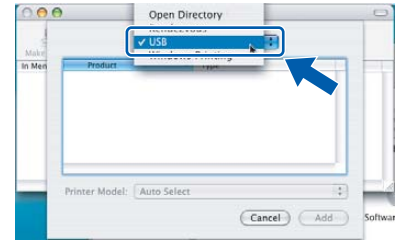

- 12 Choose **MFC-XXXX** (where XXXX is your model name), and then click **Add**.

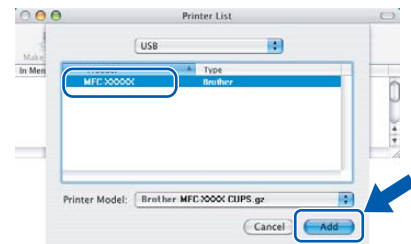

- 13 Click **Print Center**, then **Quit Print Center**.

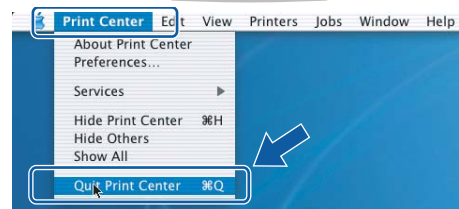
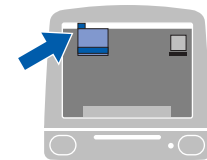

OK! The MFL-Pro Suite, Brother printer driver, scanner driver and Brother ControlCenter2 have been installed and the installation is now complete.

- 14** To install Presto!® PageManager®, click the **Presto! PageManager** icon and follow the on-screen instructions.



 **Note**

When Presto!® PageManager® is installed OCR capability is added to the Brother ControlCenter2. You can easily scan, share and organize photos and documents using Presto!® PageManager®.



Presto!® PageManager® has been installed and the installation is now complete.

Uninstalling the 'MFL-Pro Suite'

For instructions on how to uninstall the MFL Pro Suite software

Uninstalling for Windows

⊘ Improper Setup

DO NOT remove the USB cable during the uninstallation process.

Start/All Programs (Programs)/Brother/MFC-XXXX/UnInstall

- 1 Click **UnInstall**.
- 2 Click **OK**.

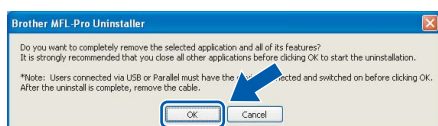

- 3 Remove the USB cable.
- 4 Click **Finish**.

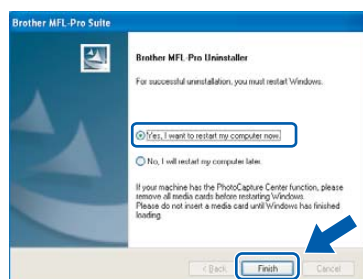

OK! The MFL-Pro Suite has been uninstalled and the uninstallation is now complete.

Uninstalling for Macintosh

How to uninstall the Printer Driver:

- 1 Disconnect the USB cable between the Macintosh and your Brother device.
- 2 Reboot the Mac.
- 3 Log on as an "Administrator".
- 4 Run the "Print Center" or "Printer Setup Utility" (from the **Macintosh HD/Applications/Utilities/Print Center** or **Printer Setup Utility** folder), then choose the printer you went to remove and remove it by clicking the "Delete" button.
- 5 Click on the model name of your Brother product in the printer list. From the Finder menu, delete the Printer.
- 6 Drag the "Brother" folder (**Macintosh HD/Library/Printers/Brother**) into the Trash bin and then empty the trash bin.
- 7 Reboot the Mac.

How to uninstall the Scanner Driver:

- 1 Disconnect the USB cable between the Macintosh and your Brother device.
- 2 Reboot the Mac.
- 3 Log on as an "Administrator".
- 4 Delete the "Brother TWAIN.ds" folder (**Macintosh HD/Library/Image Capture/TWAIN Data Sources/Brother TWAIN.ds**)

OK! The MFL-Pro Suite, Brother printer driver, scanner driver and Brother ControlCenter2 has been uninstalled and the uninstallation is now complete.

Replacement consumables

When the time comes to replace ink cartridges, an error message will be indicated on the LCD. For more information about the ink cartridges for your machine, visit <http://solutions.brother.com> or contact your local Brother re-seller.

Ink cartridge

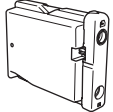
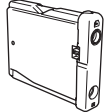
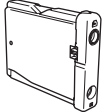
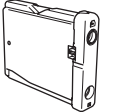
Black	Yellow	Cyan	Magenta
LC57BK	LC57Y	LC57C	LC57M
			

Trademarks

The Brother logo is a registered trademark of Brother Industries, Ltd.

Brother is a registered trademark of Brother Industries, Ltd.

Multi-Function Link is a registered trademark of Brother International Corporation.

Windows and Microsoft are registered trademarks of Microsoft in the U.S. and other countries.

Macintosh and True Type are registered trademarks of Apple Computer, Inc.

PaperPort is a registered trademark of ScanSoft, Inc.

Presto! PageManager is a registered trademark of NewSoft Technology Corporation.

PictBridge is a trademark.

Each company whose software title is mentioned in this manual has a Software License Agreement specific to its proprietary programs.

All other brand and product names mentioned in this manual are trademarks or registered trademarks of their respective companies.

Compilation and Publication

Under the supervision of Brother Industries Ltd., this manual has been compiled and published, covering the latest product descriptions and specifications.

The contents of this manual and the specifications of this product are subject to change without notice.

Brother reserves the right to make changes without notice in the specifications and materials contained herein and shall not be responsible for any damages (including consequential) caused by reliance on the materials presented, including but not limited to typographical and other errors relating to the publication.

This product is designed for use in a Professional Environment.

Copyright and License

©2006 Brother Industries, Ltd.

brother®



LP3415040
ARL/ASA/NZ
Printed in China